

B408



TF01



GB04



FC.01

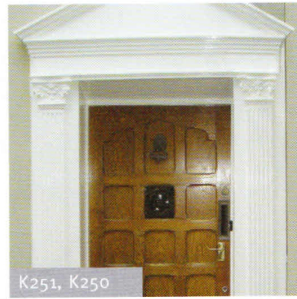

K251, K250

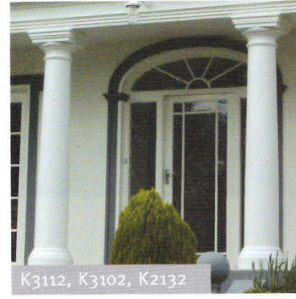

K3112, K3102, K2132



GB03



GB04

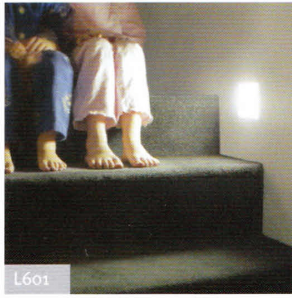

L601



L600

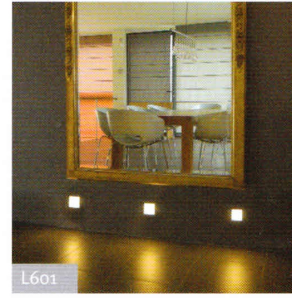

L601

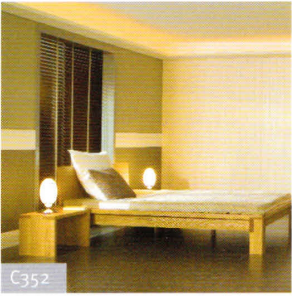

C352

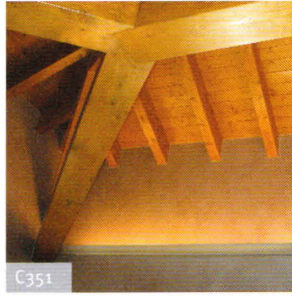

C351

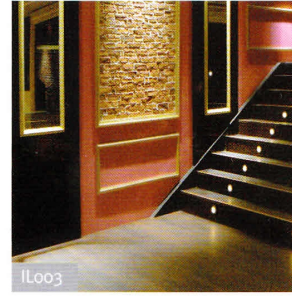

Il003

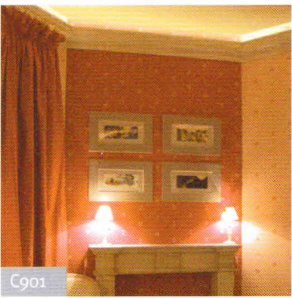

C901



C900

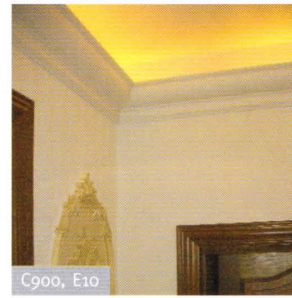

C900, E10



L504



L506

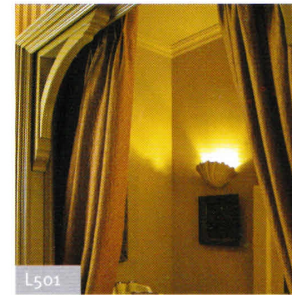

L501

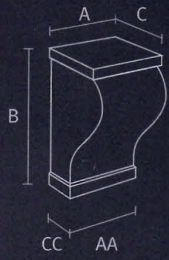

A x B x C (cm)  
AA x CC (cm)

B418  
46 x 8 x 12 cm ↑  
31 x 4,5 cm ↓



B417  
90,5 x 13,5 x 14 cm ↑  
75 x 6 cm ↓

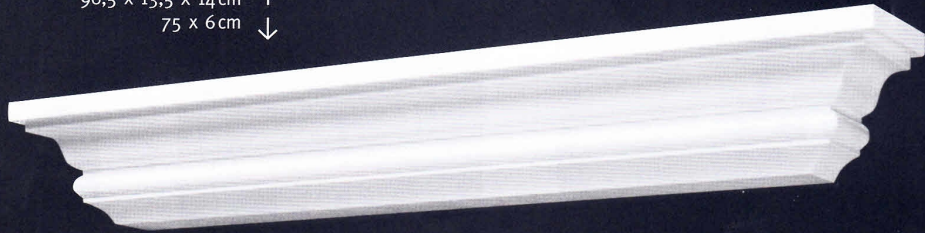

B415  
26 x 32,5 x 13 cm



B409  
30 x 35 x 17,5 cm



B413  
16 x 22,5 x 8,5 cm



B414  
10 x 22 x 7 cm



B410  
19,5 x 50 x 16 cm



B412  
20 x 35 x 20 cm



B408  
22,5 x 40 x 13 cm



B404  
19,5 x 31,5 x 11,5 cm



B403  
19 x 19 x 10 cm



B402  
9 x 22 x 7 cm



B401  
11,5 x 15,5 x 7 cm



B403

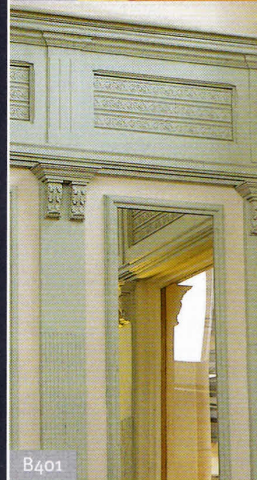

B401

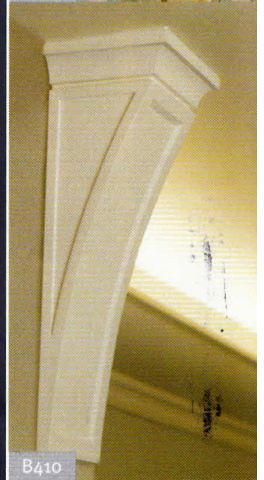

B410



N403

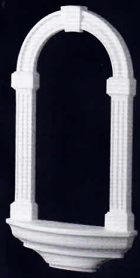

N404

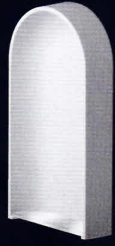

N410

N403  
+  
N410



N404  
+  
N410



N503  
+  
N510



N503  
+  
N520

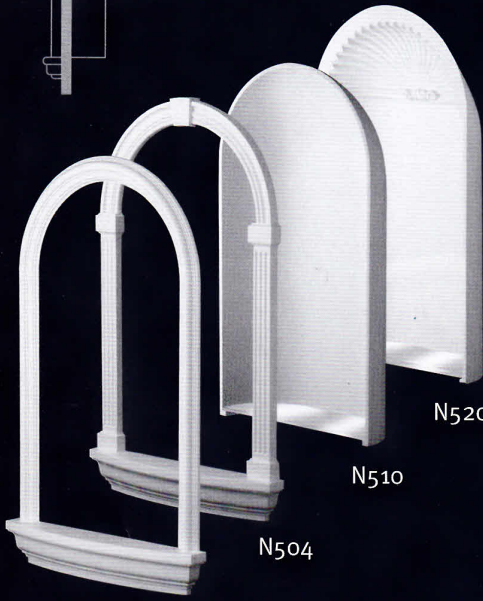

N520

N510

N504

N503

N504  
+  
N510



N504  
+  
N520



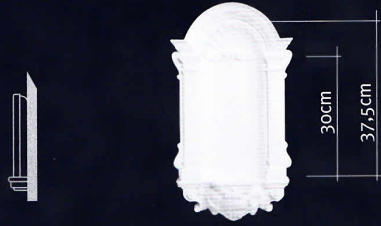

**N301**  
29 x 52,5 x 8 cm  
AA = 14,5 cm

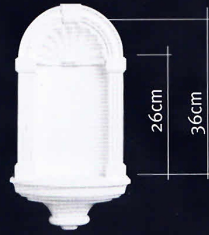

**N302**  
28 x 55 x 10,5 cm  
AA = 17 cm

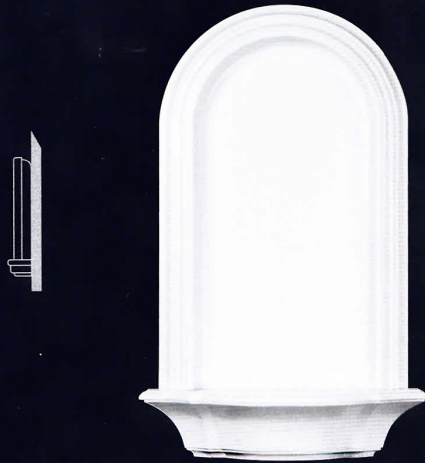

**N303**  
68 x 108 x 24 cm  
AA = 43 cm



N503 + N510

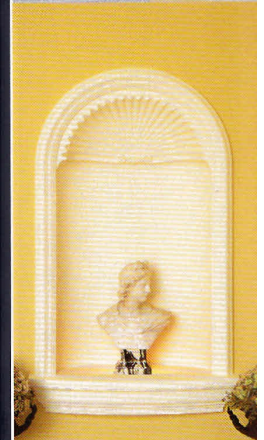

N503 + N520

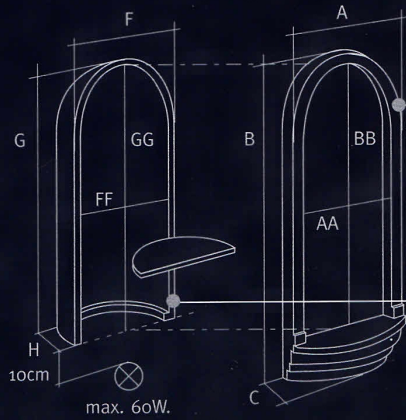

(cm)	A	B	C	AA	BB
N403	43,0	70,5	10,0	26,5	55,0
N404	42,0	76,0	11,0	24,5	55,0
N503	69,0	112,5	11,0	51,5	94,5
N504	69,0	113,0	11,0	49,5	94,5
(cm)	F	G	H	FF	GG
N410	31,0	59,5	9,5	28,0	58,5
N510	55,0	98,5	18,0	53,0	96,0
N520	55,0	97,5	18,0	53,0	92,0

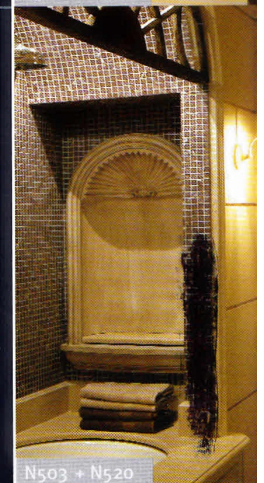

N503 + N520

H100A  
129,5 x 31 x 20,5cm

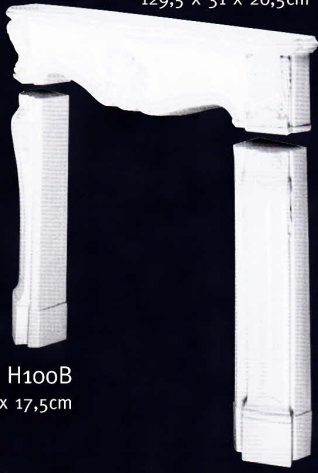

H100B  
20 x 87,5 x 17,5cm

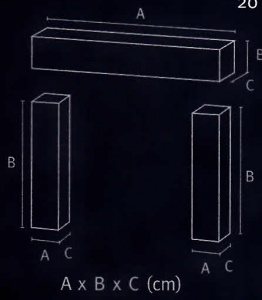

A x B x C (cm)

H100/C  
20 x 87,5 x 17,5cm

H100



max. 23 kW

H101



max. 23 kW

H101A  
129 x 24 x 20cm



H101B  
15 x 86 x 17cm

H101B  
15 x 86 x 17cm

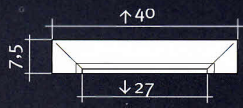

K241  
(H: 16,5 cm)

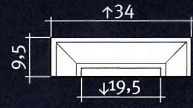

K221  
(H: 22 cm)

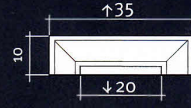

K223  
(H: 22,5 cm)

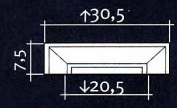

K224  
(H: 17 cm)



K240  
(H: 200 cm)

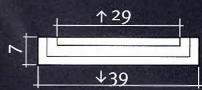

K254  
(H: 53 cm)



K220  
(H: 200 cm)

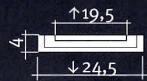
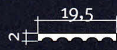

K255  
(H: 54 cm)



K220  
(H: 200 cm)

K255  
(H: 54 cm)



K220  
(H: 200 cm)

K255  
(H: 54 cm)





E10  
52 x 72 x 3,5 cm



E20  
59 x 77,5 x 5 cm



G40  
17 x 14 x 1,5 cm



G42  
40 x 4,5 x 1,5 cm



A x B x C (cm)

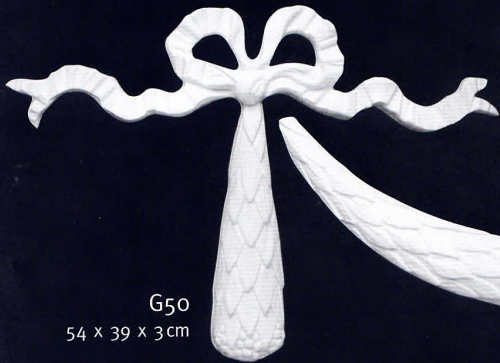

G50  
54 x 39 x 3 cm



G51  
73,5 x 9,5 x 3 cm



H101



H100, C211, DX119



E20, G50, G51



KC3 Hmax/min = 2,415m

K1152 K1002

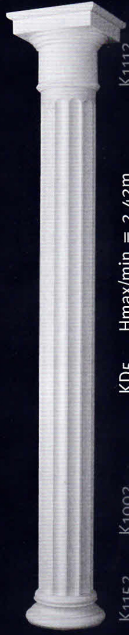

KD5 Hmax/min = 2,442m

K1152 K1002

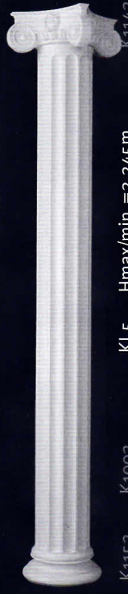

KL5 Hmax/min = 2,245m

K1152 K1002



KC1 Hmax/min = 2,425m

K1152 K1102



KD1 Hmax/min = 2,43m

K1152 K1102

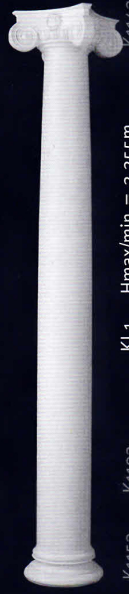

KL1 Hmax/min = 2,255m

K1152 K1102

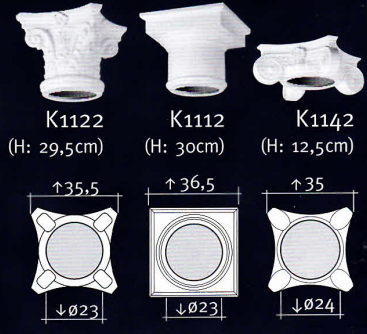

K1122 (H: 29,5cm)

K1112 (H: 30cm)

K1142 (H: 12,5cm)



KC4 Hmax = 2,865m / Hmin = 2,50m

K1132 K1002

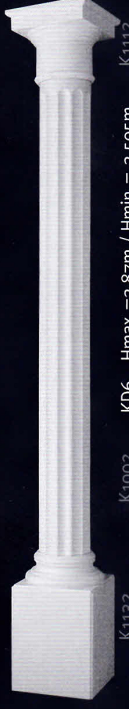

KD6 Hmax = 2,87m / Hmin = 2,505m

K1132 K1002

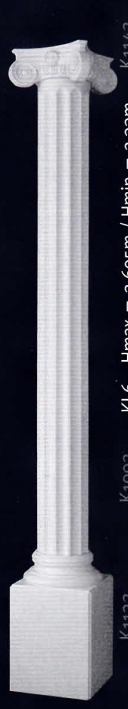

KL6 Hmax = 2,695m / Hmin = 2,33m

K1132 K1002



KC2 Hmax = 2,875m / Hmin = 2,51m

K1132 K1102

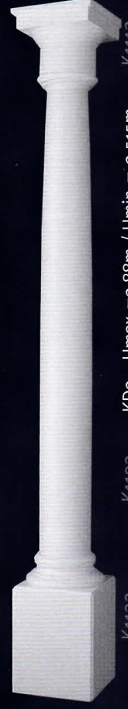

KD2 Hmax = 2,88m / Hmin = 2,515m

K1132 K1102

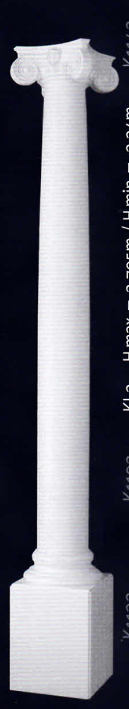

KL2 Hmax = 2,705m / Hmin = 2,34m

K1132 K1102



K1002 (H: 200cm)



K1102 (H: 201cm)



K1152 (H: 12cm)



K1132 (H: 57cm)



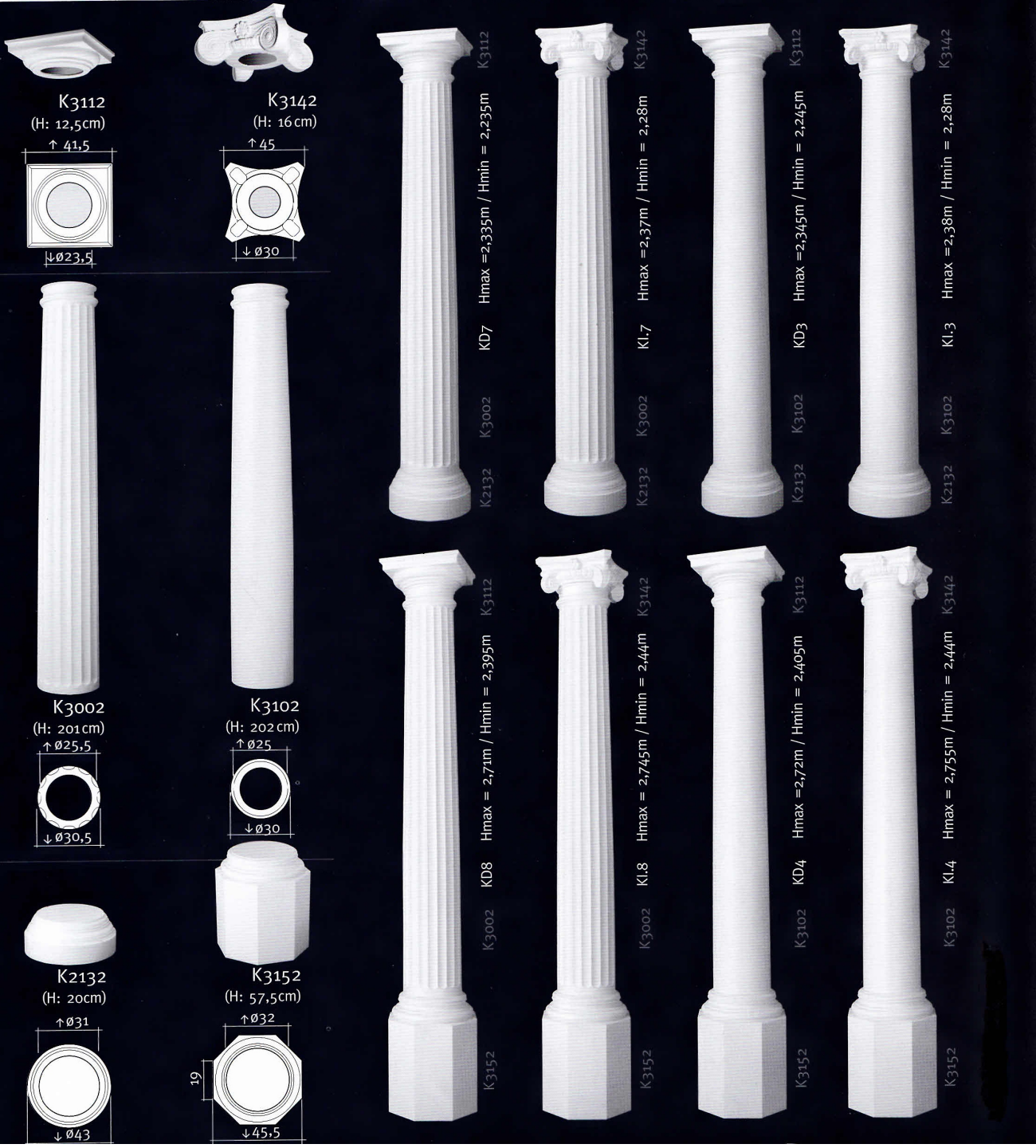

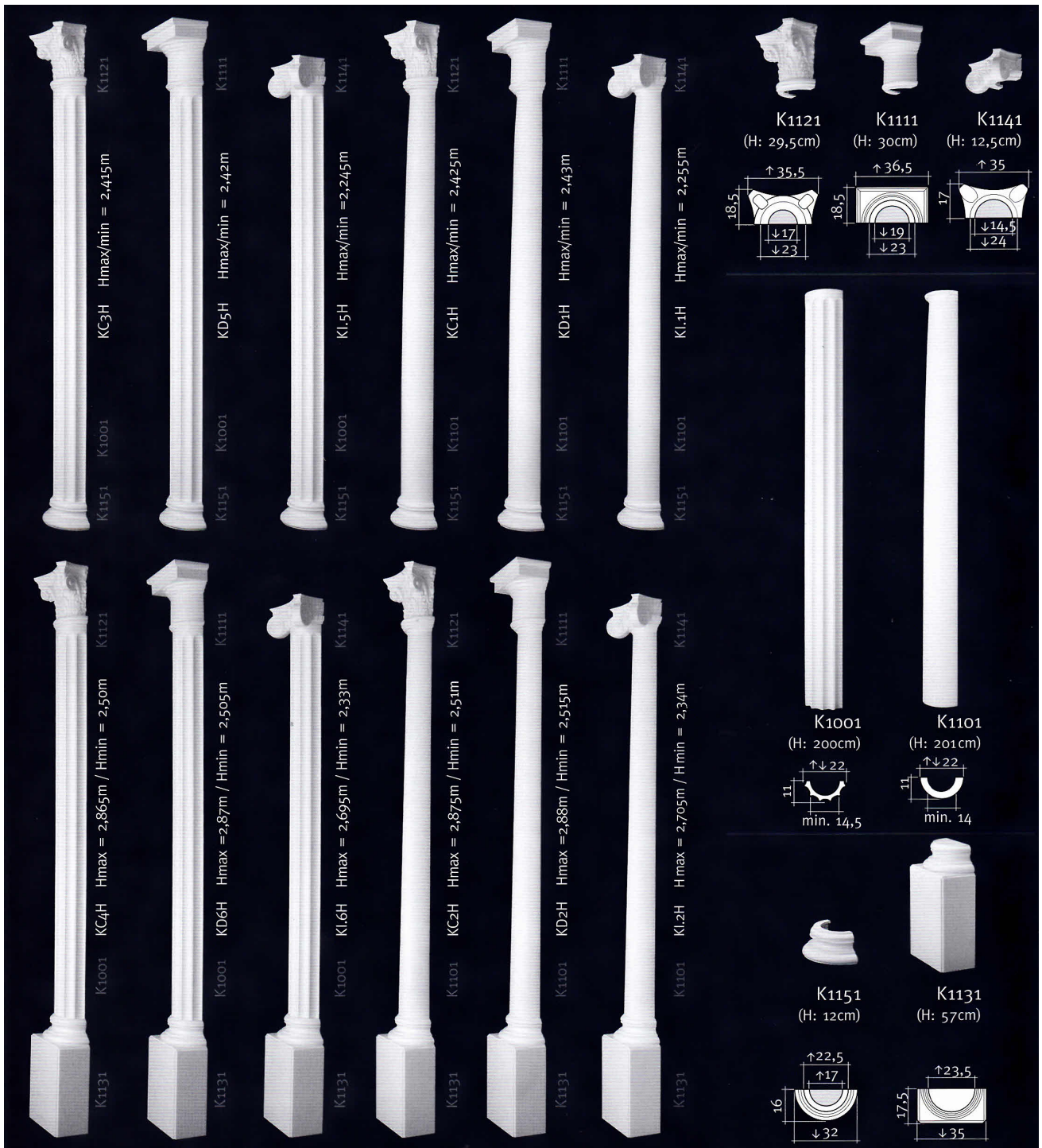

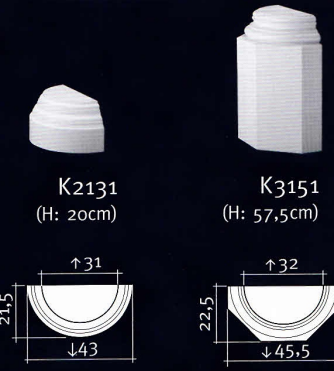
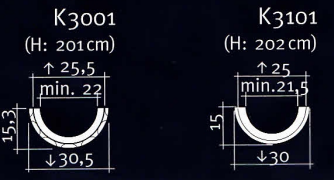
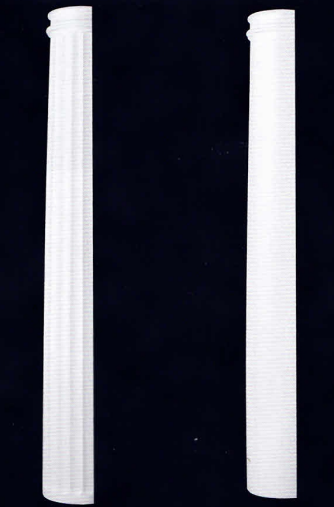
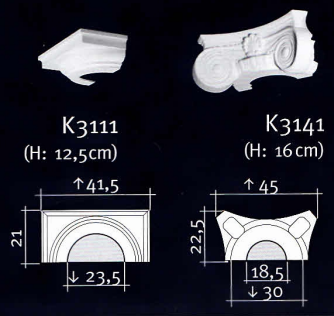

K3111 Hmax = 2,335m / Hmin = 2,235m



K3141 Hmax = 2,37m / Hmin = 2,28m



K3111 Hmax = 2,345m / Hmin = 2,245m



K3141 Hmax = 2,38m / Hmin = 2,28m



K3111 Hmax = 2,71m / Hmin = 2,395m



K3141 Hmax = 2,745m / Hmin = 2,44m

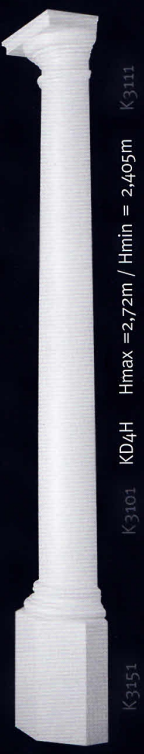

K3111 Hmax = 2,72m / Hmin = 2,405m

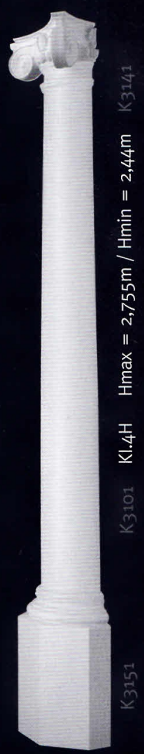

K3141 Hmax = 2,755m / Hmin = 2,44m

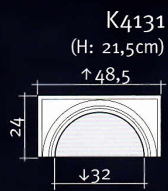
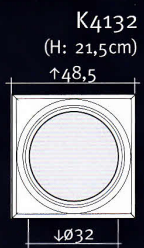

5 x K4002  
+ K4132 + K4122 = 4,09 m

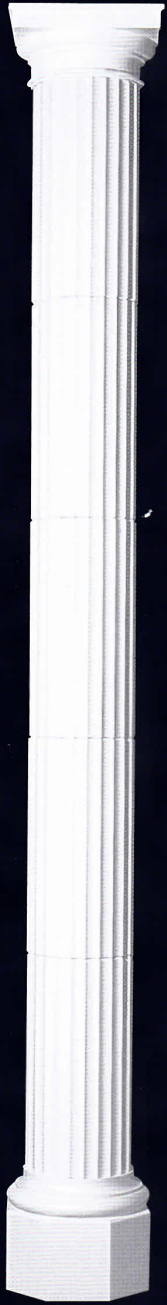

4 x K4002  
+ K4132 + K4122 = 3,39 m

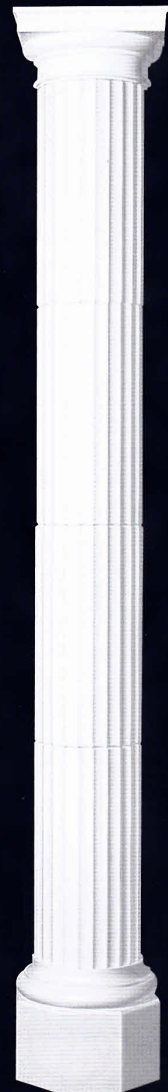

3 x K4002  
+ K4132 + K4122 = 2,69 m

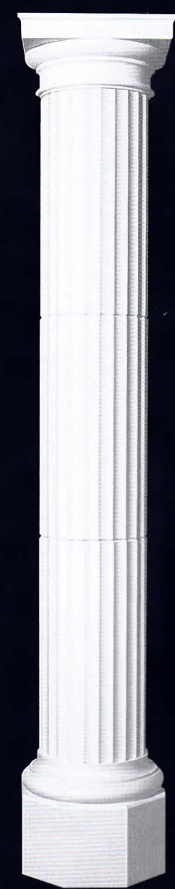

K4002  
(H: 72cm)

K4001  
(H: 72cm)

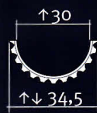

K4122  
(H: 40,5cm)

K4121  
(H: 40,5cm)

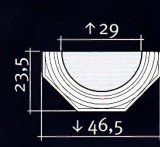
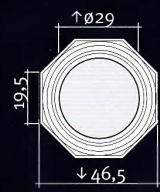

FC01  
8 x 35 x 39 cm



TF01  
7,7 x 12,3 x 35 cm

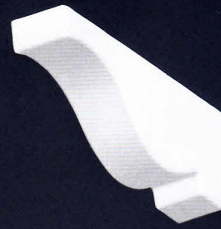

GB03  
7 x 63 x 58 cm  
structural max. 75 kg



TF02  
7,7 x 12 x 10,5 cm



GB04  
5 x 74,5 x 77 cm  
structural max. 75 kg



TF03  
7,8 x 10 x 20 cm



TF04 - (180° rotated)  
7,7 x 25 x 20 cm



TF05  
10 x 13,5 x 25,5 cm

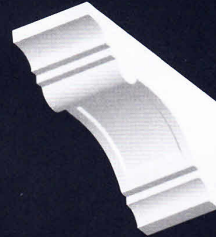

TF06  
15,5 x 7,5 x 17,5 cm

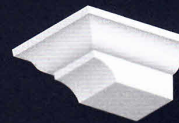

A x B x C (cm)

